

Scarlett Octo Pre

User Guide

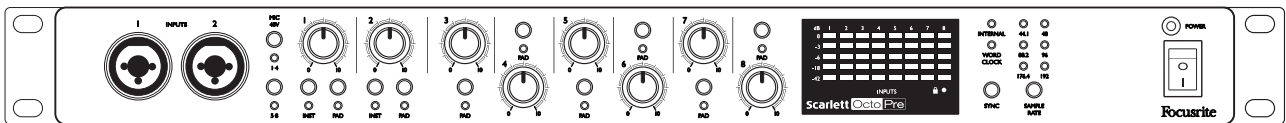

TABLE OF CONTENTS

OVERVIEW	3
Introduction	3
Features	3
Box Contents	4
Hardware Features	5
Front Panel	5
Rear Panel	6
USING THE SCARLETT OCTOPRE	7
Combo Inputs	7
Phantom Power	7
Pre-amp Gain	7
Pad Switch	7
Line Outputs	8
LED Metering	8
Digital Outputs	8
Digital Synchronisation	9
Scarlett OctoPre as Clock Source Master via ADAT	9
Scarlett OctoPre as Clock Source Master via word clock	9
Scarlett OctoPre as Clock Source Slave via word clock	9
EXAMPLE SETUPS	10
1.Scarlett OctoPre with audio interface: OctoPre as clock source Master	10
2.Scarlett OctoPre with audio interface: audio interface as clock source Master	10
3. Scarlett OctoPre with audio interface – SMUX-II and SMUX-IV modes	11
4.Scarlett OctoPre with analogue mixing desk	11
5.Scarlett OctoPre with analogue mixing desk and digital record/backup	12
SCARLETT OCTOPRE TECHNICAL SPECIFICATIONS	13
Performance Specifications	13
Physical and Electrical Characteristics	14
TROUBLESHOOTING	15
COPYRIGHT AND LEGAL NOTICES	15

OVERVIEW

Introduction

Thank you for purchasing a Scarlett OctoPre, an eight channel mic-pre expansion unit incorporating high quality Focusrite analogue pre-amplifiers.

The Scarlett OctoPre comprises eight natural sounding, low noise preamps with plenty of gain; eight line inputs and two high headroom instrument inputs, coupled with high quality digital conversion to ADAT format. You can now expand your studio set-up or live rig by adding Focusrite quality mic preamps and conversion to any interface with ADAT I/O.

The Scarlett OctoPre has both digital and analogue outputs: in addition to dual ADAT optical ports it also provides a balanced line output from each channel, enabling you to connect it directly to any analogue device.

This User Guide provides a detailed explanation of the hardware to help you achieve a thorough understanding of the product's operational features. We recommend that you take the time to read through the Guide, whether you're new to professional audio or a more experienced user, so that you are fully aware of all the possibilities the Scarlett OctoPre has to offer.

If the User Guide sections do not provide the information you need, be sure to consult <https://support.focusrite.com>, which contains a comprehensive collection of answers to common technical support queries.

Features

The Scarlett OctoPre is an eight-channel pre-amplifier for use with microphone, line and instrument input signals. It converts the inputs into multi-channel, 24-bit digital audio at sample rates up to 192 kHz. The digital outputs are in ADAT format on optical TOSLINK connectors, which can be easily routed to ADAT inputs on your studio recording system, or any other ADAT-equipped interface using optical cables. The Scarlett OctoPre can transmit eight channels of audio at sample rates of 44.1, 48, 88.2, or 96 kHz, or four channels at 176.4 or 192 kHz provided, of course, that the receiving interface is able to handle the same number of channels at the sample rate in use.

The Scarlett OctoPre is an ideal "expansion" unit for adding up to eight more inputs to any audio interface with ADAT I/O.

The Scarlett OctoPre can be easily synchronised with other digital audio equipment in your studio, either as a slave to an external word clock signal, or by acting as the master clock source itself.

Box Contents

Along with your Scarlett OctoPre you should have:

- AC mains cable with IEC connector
- 4 x self-adhesive feet – stick to underside of unit for table-top use

Printed on the inside of the box:

- Getting Started Guide
- Bundle Code for on-line product registration*

*After registration, you will have access to downloads and licences for the following software:

Softube Time and Tone bundle

Focusrite Red 2 and Red 3 plug-in suite

Hardware Features

Front Panel

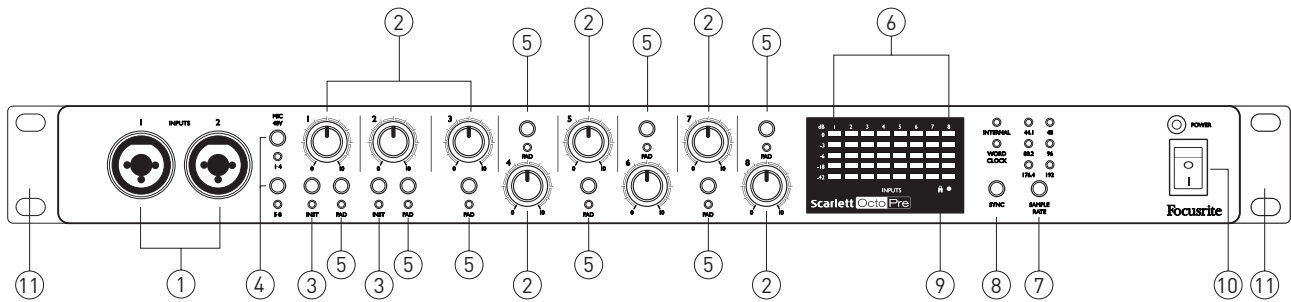

All operational controls and metering for all eight channels are on the front panel.

1. **INPUTS 1 to 2** – 2 x “Combo XLR” input sockets for Channels 1 and 2 - connect microphones or line level signals via XLR or ¼” jacks: either TRS (balanced) or TS (unbalanced) jack plugs can be used for instruments or line level signals. Note that the inputs for Channels 3 to 8 are on the rear panel [12].
2. Input gain controls **1 to 8** - eight rotary controls: adjust the input gain for the signals in Channels 1 to 8 respectively.
3. **INST** – two latching switches which put Inputs 1 and 2 into “Instrument” mode. When INST is selected, the gain range and input impedance are altered (relative to LINE), and the input is made unbalanced. This optimises it for the direct connection of instruments via a 2-pole (TS) jack plug. When INST is off, the inputs are suitable for the connection of line level signals. Line level signals may be connected either in balanced form via a 3-pole (TRS) jack or unbalanced, via a 2-pole (TS) jack. Each switch has an adjacent green LED to confirm selection.
4. **MIC 48V (1-4 & 5-8)** – two latching switches, each enabling 48 V phantom power at the XLR contacts of four inputs: Channels 1 to 4 and 5 to 8 respectively. Each switch has an associated red LED indicating that phantom power is selected.
5. **PAD** – a latching switch for each channel, reducing the channel gain by 8 dB when selected. A red LED adjacent to each switch confirms PAD selection.
6. Input signal level meters: eight LED meters, one per channel. These show the signal level in each channel post the input gain control, so you can see the level being sent to the output.
7. **SAMPLE RATE** – a soft switch which steps through the six available sample rate settings, the current rate being indicated by one of the adjacent green LEDs. The sample rate in use is stored in memory so that it is retained when the unit is switched off.
8. **SYNC** – a soft switch which selects the digital sync source for the Scarlett OctoPre (Internal or Word Clock), the selected source being indicated by one of the adjacent red LEDs. The source in use is stored in memory so that it is retained when the unit is switched off.
9. **🔒** – a green “Locked” LED which illuminates when the unit has locked to the available sync source, indicating that it is ready to use.
10. **POWER** – AC power switch and green LED.
11. Rack ears for mounting the Scarlett OctoPre in a standard 19” equipment rack.

Rear Panel

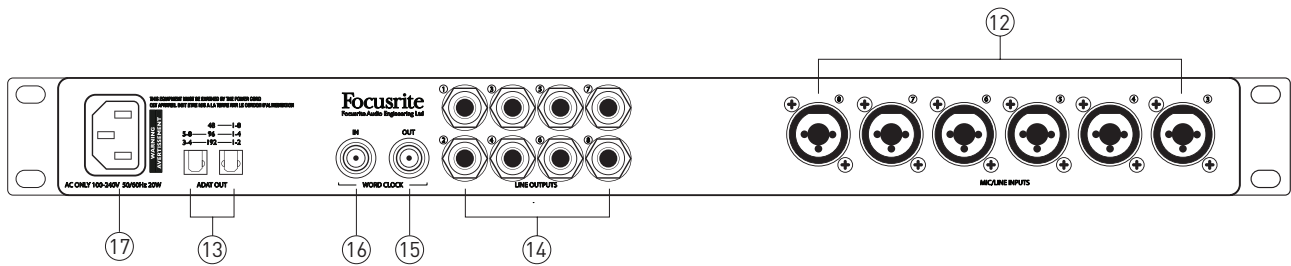

The remainder of the Scarlett OctoPre’s inputs and outputs are on the rear panel.

12. **INPUTS 3 to 8** – 6 x “Combo XLR” connectors; note that the inputs for Channels 3 to 8 do not have INST mode, but are otherwise identical to those for Channels 1 and 2.
13. **ADAT OUT** – two TOSLINK connectors providing the digital outputs of the unit. Utilisation of the two connectors is sample rate-dependent, as follows:

Sample Rate	OUTPUT 1 (RH port*)	OUTPUT 2 (LH port*)
44.1/48 kHz	Channels 1 to 8	Channels 1 to 8
88.2/96 kHz	Channels 1 to 4	Channels 5 to 8
176.4/192 kHz	Channels 1 & 2	Channels 3 & 4

* As viewed looking at rear panel

14. **LINE OUTPUTS 1 to 8** – eight balanced analogue line outputs on ¼” 3-pole (TRS) jack sockets. These connectors are always active, and carry the outputs of Channels 1 to 8, enabling the Scarlett OctoPre to be used as a stand-alone, high quality 8-channel analogue mic pre.
15. **WORD CLOCK OUT** – a BNC connector carrying the Scarlett OctoPre’s word clock signal; this may be used to synchronise other digital audio equipment forming part of the recording system. The source of sample clock synchronisation is selected by the SYNC switch [8].
16. **WORD CLOCK IN** – a BNC connector for the connection of an external word clock signal; select by setting **SYNC** to WORD. Use this input if you have a master reference clock which provides synchronisation for all the digital audio devices in your studio.
17. **AC mains** – standard IEC receptacle. The Scarlett OctoPre is fitted with a “Universal” power supply, and will run from any AC mains voltage from 100 to 240 V, at 50 or 60 Hz.

USING THE SCARLETT OCTOPRE

Combo Inputs

All eight of the analogue inputs use “Combo XLR” connectors. These can accept male XLR connectors, TS (unbalanced) ¼” jacks or TRS (balanced) ¼” jacks.

When an XLR connector is used, the pre-amp automatically configures gain and impedance to receive microphone level signals. If a ¼” connector is used, the pre-amp is set to accept balanced or unbalanced line level signals. When INST mode is selected (on Channels 1 or 2), the ¼” input reconfigures again to optimise for an unbalanced, high impedance signal.

Phantom Power

The two **48V** switches apply 48 V phantom power to Mic inputs 1 to 4 and 5 to 8 respectively. Phantom power is required by most condenser (capacitor) microphones. Phantom power is only applied to the XLR contacts of the Combo connectors: thus if a group of four inputs is being used for both mic and line (or instrument) level signals, phantom power is only applied to the microphones.

Dynamic microphones do not require phantom power, but most will operate normally with phantom power supplied. Passive ribbon microphones do not require phantom power and may be damaged if supplied with phantom power.

If you are unsure about a microphone DO NOT apply phantom power without checking the manufacturer’s specifications first.

Pre-amp Gain

The gain of each channel should be adjusted to suit the incoming level; louder sources will need less gain than quieter ones. Always use the LED meters to check the signal level on each channel.

Start with the Gain control set to minimum. Play (or sing) at the loudest level that is likely to be reached during the song, and gradually increase the gain until the meter shows orange (-3 dB). Then lower the gain by a few dB. This should ensure that the signal level is unlikely to ever reach red (0 dB) and overload the A-to-D converter, which would result in distortion.

Pad Switch

Each channel of the Scarlett OctoPre is equipped with a switchable 8 dB **PAD**. Selecting PAD increases the headroom of the input stage, and should be used to reduce mic or line level signals which are ‘too hot’. It is not intended for use with the Instrument inputs in Channels 1 or 2. The associated red LED illuminates when PAD is selected.

Line Outputs

By connecting the line outputs of the Scarlett OctoPre to the analogue line inputs of a mixing console (or any other device), the unit can be used either as a purely analogue, 8-channel microphone pre-amplifier.

The line outputs are balanced: for a balanced connection use ¼" 3-pole (TRS) jacks, or ¼" 2-pole (TS) jacks for an unbalanced connection.

The maximum output signal level is +16 dBu (balanced), or +10 dBu (unbalanced).

LED Metering

The eight five-segment LED meters show the level of the signal at the input to the analogue-to-digital converters - i.e., after both the pre-amplifier and compressor stages.

The segments illuminate at the following signal levels: -42 dBFS, -18 dBFS, -6 dBFS (green), -3 dBFS (yellow), and 0 dBFS (red).

When using the digital ADAT outputs, you should ensure that the channel gain settings (with or without PAD selected, as necessary) are such that the signal level never reaches 0 dBFS – i.e., the red LED should never light.

Digital Outputs

Use the **ADAT OUT** optical port(s) [13] to connect the Scarlett OctoPre to the ADAT input(s) of an audio device using TOSLINK optical cable(s).

The right-hand port (as viewed from the rear of the unit) can transmit eight channels of audio at 44.1 kHz or 48 kHz sample rate via a single optical cable.

At 88.2 kHz or 96 kHz sample rates, each port can transmit four channels of audio. The right-hand port carries Channels 1 to 4, the left-hand port carries Channels 5 to 8; thus two TOSLINK cables are required to transmit all eight channels.

At 176.4 kHz or 192 kHz sample rates, each port can transmit two channels of audio. The right-hand port carries Channels 1 and 2, the left-hand port carries Channels 3 and 4. The Scarlett OctoPre is restricted to four channels of digital audio at these sample rates; the outputs of Channels 5 to 8 are not available via the ADAT ports.

Use the **SAMPLE RATE** switch [7] to select the desired sample rate frequency. It is essential that the sample rate selected on the Scarlett OctoPre matches the sample rate set on the receiving digital device.

Digital Synchronisation

A number of synchronisation options are available:

Scarlett OctoPre as Clock Source Master via ADAT:

Connect the Scarlett OctoPre to the receiving digital device via the ADAT OUT port(s) and ensure that the receiving device is set to source its clock from its ADAT input and also that the sample rates on both devices match.

On the OctoPre, **SYNC** should be set to INTERNAL and the  LED will illuminate.

Scarlett OctoPre as Clock Source Master via word clock:

An alternative method to the above is to sync the receiving device to the Scarlett OctoPre's **WORD CLOCK OUT** using a BNC cable. In this scenario, the receiving device's sync source will need to be set to its external word clock input.

Scarlett OctoPre as Clock Source Slave via word clock:

Connect the Scarlett OctoPre to the receiving digital device via the **ADAT OUT** port(s) and connect a BNC cable from the digital device's word clock output to the OctoPre's **WORD CLOCK IN** connector. Select WORD CLOCK with the **SYNC** switch and also ensure that the sample rates on all devices match.

EXAMPLE SETUPS

1. Scarlett OctoPre with audio interface: OctoPre as clock source Master

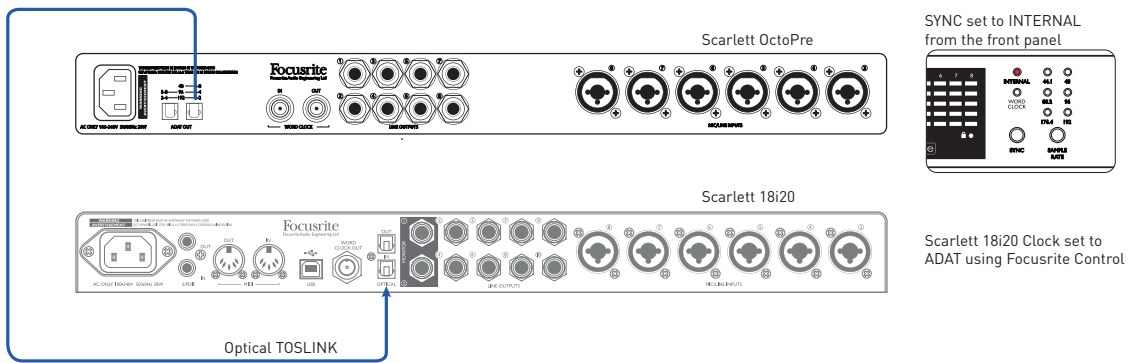

Here **ADAT OUT** on the Scarlett OctoPre is connected to **OPTICAL IN** on a Scarlett 18i20 audio interface with a single optical cable. Both units are running at 44.1 kHz sample rate. The OctoPre's clock source is set to INTERNAL, and the 18i20 is synchronised to it because its clock source is set to ADAT (via Focusrite Control).

This setup would, for example, enable up to 16 mic or line sources to be recorded in a DAW simultaneously, and would thus be ideal for recording a live band.

The setup would also be appropriate for any other audio interface which has an ADAT input.

2. Scarlett OctoPre with audio interface: audio interface as clock source Master

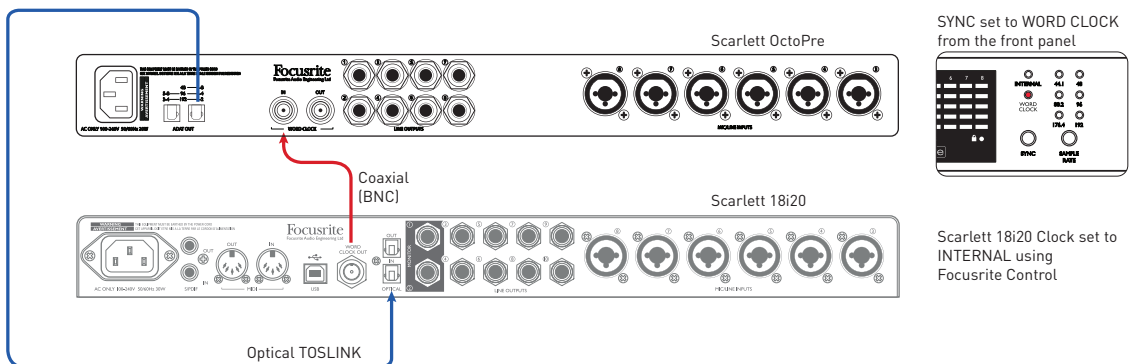

Here **ADAT OUT** on the Scarlett OctoPre is connected to **OPTICAL IN** on a Scarlett 18i20 audio interface with a single optical cable. Both units are running at 44.1kHz sample rate. The OctoPre's **WORD CLOCK IN** input is connected to **WORD CLOCK OUT** on the Scarlett 18i20 with a BNC cable and the OctoPre's clock source is set to WORD CLOCK. The 18i20's clock source is set to INTERNAL (via Focusrite Control), thus making it the sync master.

The setup would also be appropriate for any other audio interface which has an ADAT input and a word clock output.

3. Scarlett OctoPre with audio interface – SMUX-II and SMUX-IV modes

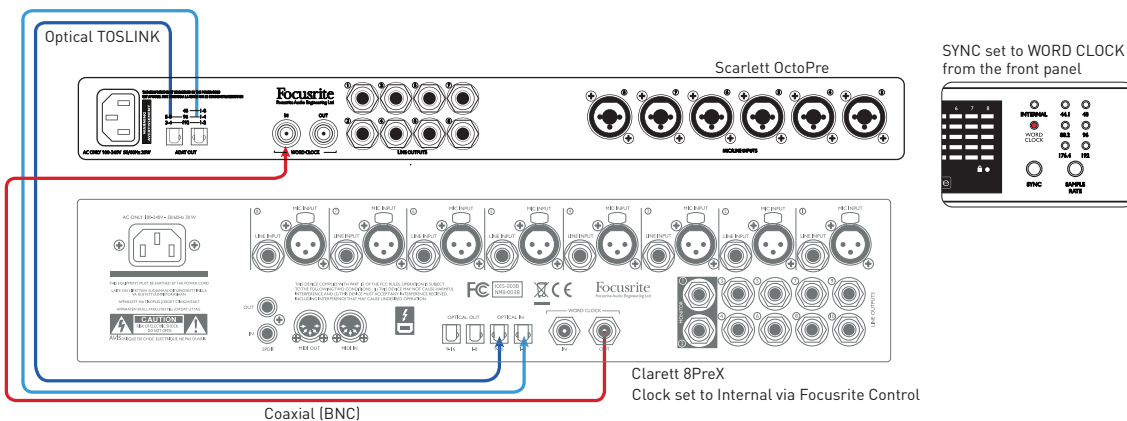

This example shows a similar setup to Example 2, but using a Focusrite Clarett 8PreX allows operation at a sample rate of 96 kHz (“SMUX-II” mode). Both units must be set to 96 kHz; two optical cables are used, carrying four channels of audio each. The Clarett 8PreX is the sync master.

This setup is also applicable with 192 kHz sample rate (“SMUX-IV” mode); each optical cable will then carry two channels of audio.

4. Scarlett OctoPre with analogue mixing desk

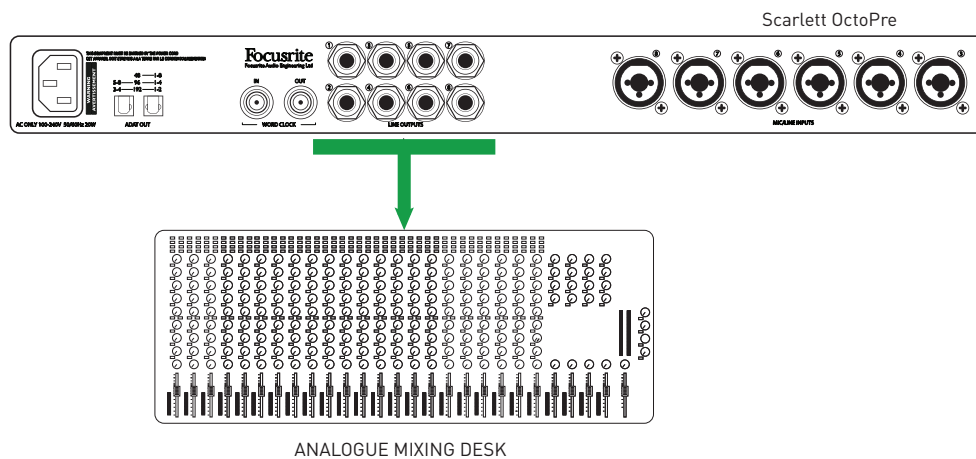

This setup uses the Scarlett OctoPre’s mic pre-amplifiers to provide a high quality “front end” for an analogue mixing desk. Use a pre-made loom to connect the OctoPre’s **LINE OUTPUTS** socket to eight line inputs on the mixing desk; this will need eight ¼” TRS jacks on one end and eight connectors appropriate to the desk’s line inputs on the other. If the desk’s line inputs are unbalanced, a loom with TS jacks at the OctoPre end will be suitable.

This setup would also be appropriate to use the OctoPre as an input stage with any type of 8-channel analogue device.

5. Scarlett OctoPre with analogue mixing desk and digital record/backup

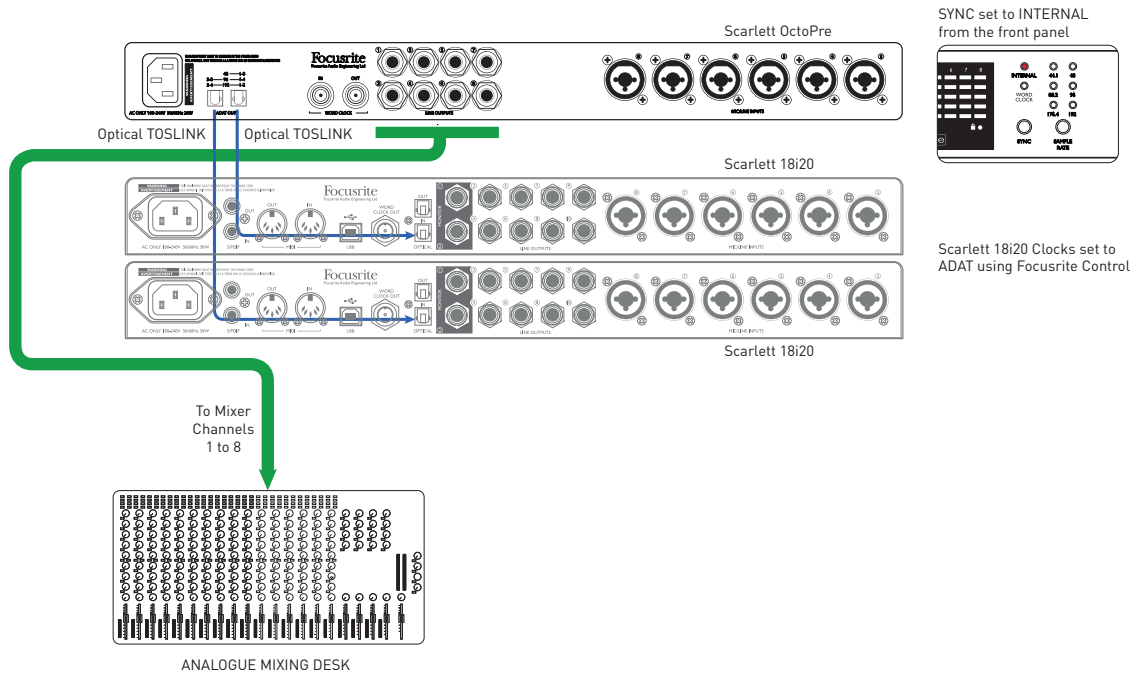

This example shows how the setup in Example 4 can be extended to add simultaneous digital recording, with or without secondary backup.

Because the Scarlett OctoPre's **ADAT OUT** ports are always active, you can record the performance on a DAW (or other recording device) with an ADAT interface. The example shows two Scarlett 18i20s: the **ADAT IN** port of each would be connected to the two **ADAT OUT** ports of the OctoPre, to provide 8-track recording (on the first) and a simultaneous 8-track backup on the second, at sample rates of 44.1 or 48 kHz.

8-track recording could still be achieved at 88.2 or 96 kHz, although each Scarlett 18i20 would provide 4 channels to the DAW; backup would not be possible.

SCARLETT OCTOPRE TECHNICAL SPECIFICATIONS

Performance Specifications

(All performance figures are measured to the AES17 standard).

Sample Rates	
Supported sample rates	44.1 kHz, 48 kHz, 88.2 kHz, 96 kHz, 176.4 kHz & 192 kHz
Microphone Inputs	
Frequency Response	20 Hz to 20 kHz, +0.5/-1.5 dB
Dynamic Range	109 dB (A-weighted)
THD+N	<0.001%
Noise EIN	-127 dBu
Maximum input level (without PAD)	+8 dBu
Maximum input level (with PAD)	+16 dBu
Gain Range	50 dB
Input Impedance	3 k Ω
Line Inputs	
Frequency Response	20 Hz to 20 kHz, +0.5/-1.5 dB
Dynamic Range	109 dB (A-weighted)
THD+N	<0.002%
Maximum input level	+22 dBu
Gain Range	50 dB
Input Impedance	49 k Ω
Instrument Inputs	
Frequency Response	20 Hz to 20 kHz, +0.5/-1.5 dB
Dynamic Range	108 dB (A-weighted)
THD+N	<0.01%
Maximum input level	+13 dBu
Gain Range	50 dB
Input Impedance	1 M Ω
Line Outputs	
THD+N	<0.001%
Maximum Output Level (0 dBFS)	>+16 dBu @ 0 dBFS, or >21 dBu where ADAT output is not used
Output Impedance	136 Ω (Balanced) - for units with serial number \leq W860083007515
	576 Ω (Balanced) - for units with serial number > W860083007515*

* As a result of a component change in the Scarlett OctoPre and Scarlett OctoPre Dynamic designs, some units have a higher output impedance. This change has been fully tested and has no impact on the audio performance. Please see the table above for the impedance of Scarlett OctoPre by serial number range:

Physical and Electrical Characteristics

Analogue Inputs	
Connectors	"Combo XLR" sockets on rear panel; for Line use ¼" TRS jack, for Inst use ¼" TS jack.
Mic/Line switching	Automatic
Line/Instrument switching (Chs. 1 & 2 only)	via front 2 x front panel switches
Phantom power	+48 V, switchable Chs. 1-4, 5-8 in groups
Outputs	
Analogue outputs	8 x balanced, on rear panel ¼" TRS jack sockets
Other I/O	
ADAT Output	4 x TOSLINK optical connectors: 8 channels at 44.1/48 kHz (RH port*) 8 channels at 88.2/96 kHz (Chs 1-4 RH port*, 5-8 LH port*) 4 channels at 176.2/192 kHz (Chs 1 & 2 RH port*, 3 & 4 LH port*)
Word clock output	2.5 V (correctly terminated with 75 ohms); BNC connector
Word clock input	BNC connector: 5 V into 75 ohms
Weight and Dimensions	
W x D x H	482 mm x 44.5 mm x 286 mm 19" x 1.75" x 11.26"
Weight	3.22 kg 7.10 lbs

* ADAT port as viewed from rear of unit.

TROUBLESHOOTING

For all troubleshooting queries, please visit the Focusrite Answerbase at <https://support.focusrite.com> where you will find articles covering numerous troubleshooting examples.

COPYRIGHT AND LEGAL NOTICES

Focusrite is a registered trade mark and Scarlett OctoPre is a trade mark of Focusrite Audio Engineering Limited.

All other trade marks and trade names are the property of their respective owners.
2016 © Focusrite Audio Engineering Limited. All rights reserved.