

User Guide



IMPORTANT SAFETY INSTRUCTIONS:



The device has been tested for conformance to safety regulations and requirements, and has been certified for international use. However, like all electronic equipment, the device should be used with care. Please read and follow the safety instructions to protect yourself from possible injury and to minimize the risk of damage to the unit.

- Please do not place the display screen towards the ground to avoid scratching the LCD surface.
- Please avoid heavy impact.
- Please do not use chemical solutions to clean this product. Simply wipe with a clean soft cloth to maintain the brightness of the surface.
- Please do not block any vent hole.
- Please follow the instructions and trouble-shooting to adjust the product.
- Internal adjustments or repairs must be performed by a qualified technician.
- Please keep user guide for future reference.
- Please unplug the power and remove the battery if long-term no-use, or thunder weather.

FEATURES:

- 4K HDMI input & loop output,
- 1920x1080, Full HD resolution,
- 400cd/m² high brightness,
- 1000:1 high contrast,

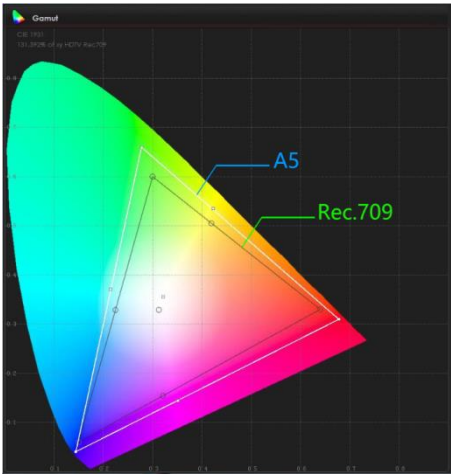

- Plenty of Camera Auxiliary Functions
- 118G Light-weight Design
- Color Space

The wide color space supporting ITU-R BT.709, matching with strict color calibration that makes accurate color reproduction and excellent grayscale.

YP-01180324-3

CONTENT

1. INSTALLATION & INITIAL SETUP.....	3
2. TOP&REAR PANEL FEATURES	4
3. DV BATTERY MOUNT PLATE.....	5
4. MENU SETTING	6
5. MENU OPERATION.....	7
6. ACCESSORIES	18
7. PARAMETERS.....	18
8. TROUBLE SHOOTING	19

1. INSTALLATION & INITIAL SETUP

Unpacking

Carefully unpack the device and verify that the accessories list under Chapter 6 are included.

Inspect the unit for any physical damage that may have occurred during shipping. Should there be any damage, immediately contact the Service.

Connections, Power-On and Initial Setup

Plug the power supply into an AC power source.

Attach the Power connector to the back of the monitor.

Connect the required cables for the signal input and output.

Press the Power button to turn the unit on.

WARNING

USB interface Only for program upgrades, do NOT use if non-professionals and do NOT use for power connect.

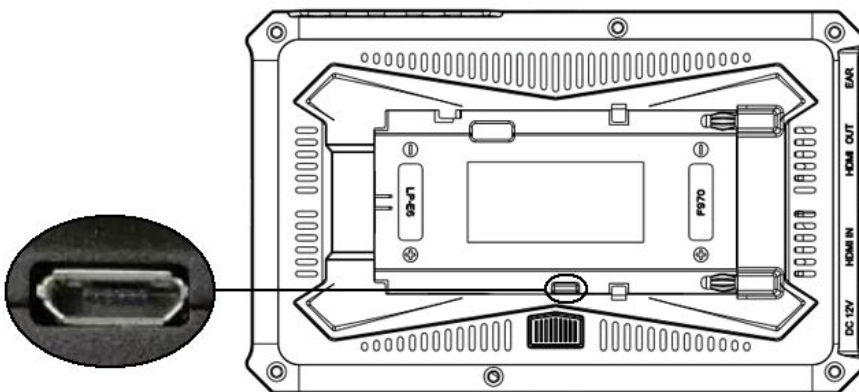

2.TOP&REAR PANEL FEATURES

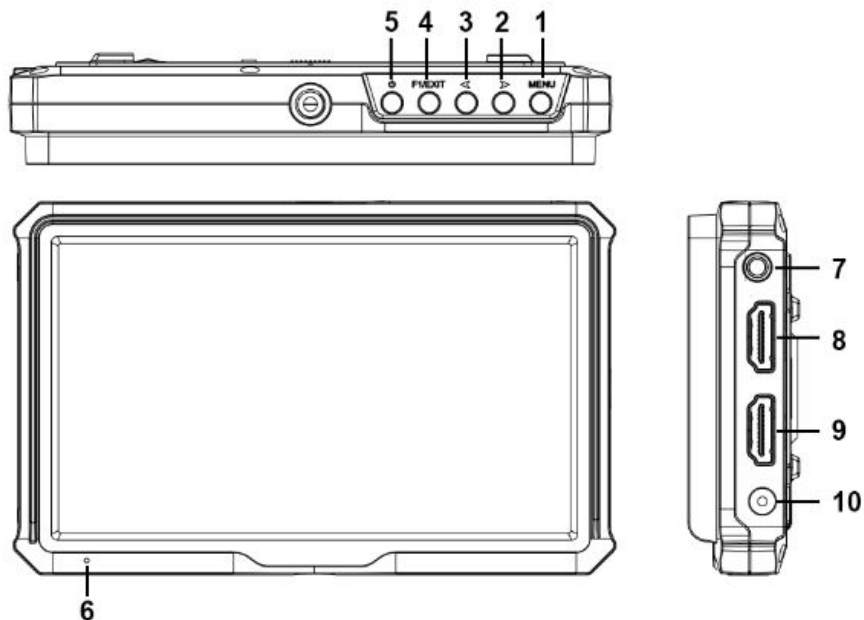

1. **MENU** button:
Menu key: press to display menu on the screen when screen is lit.
Confirm key: press to confirm the selected option.
2. **▶** Right selection key: Select option in the menu. Increase the option value.
3. **◀** Left selection key: Select option in the menu. Decrease the option value.
4. **F1&EXIT**: To return or exit the menu function.
F1 User-definable function buttons. Default : Peaking
5.  Power on / off.
6. Power indicator light
7. Earphone

8. HDMI output interface.
9. HDMI input interface.
10. DC 12V power input.

3. DV BATTERY MOUNT PLATE

Standard mounts process



- ① First place battery plate into the plate,

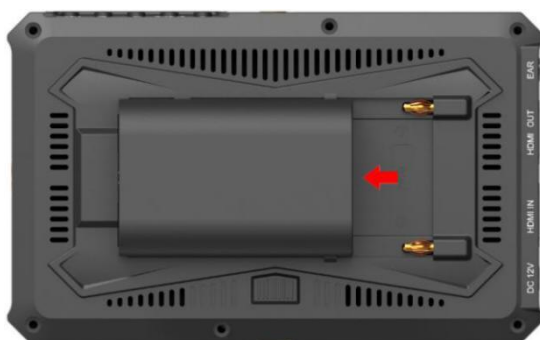

- ② Please slide LP-E6 battery to the left.

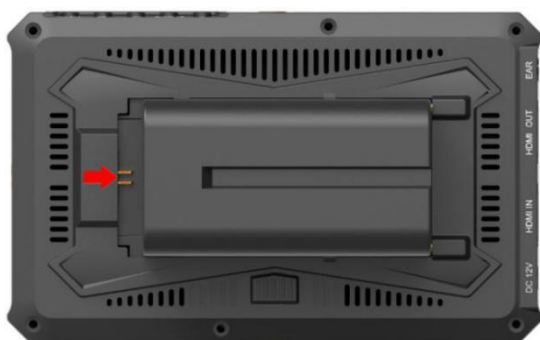

- ③ Please slide F970 battery to the right.

DV Battery Mount Plate Specification

Model F970 for battery of SONY DV:

DCR-TRV series, DCR-TRV E series, VX2100E PD P series, GV-A700, GV-D800 FD/CCD-SC/TR3/FX1E/HVR-AIC, HDR-FX1000E, HVR-Z1C, HVR-V1C, FX7E F330.

Model LP-E6 for battery of Canon DSLR:

D Mark II/5D Mark III/EOS7D/EOS60D;

4. MENU SETTING

Before setting the functions, please make sure the monitor is connected correctly.

4-1. The image menu:

Press ◀/▶ button to activate the brightness bar when not under the menu display

Press again to adjust the value of option directly.

Press "F1/EXIT" to exit if accidentally enter the menu.

After enter the Volume menu, press "MENU" to select among of brightness, contrast, saturation, tint, sharpness , volume, exit and MENU.

4-2. Shortcut key: F1 user-definable function button

Select "MEMU -- SYSTEM -- F1 Configuration" to custom F1 shortcut setting. Then press ◀/▶ button to choose options.

Press "MENU" to confirm option as default, then press EXIT to exit.

Function of F1 button can also be customized: Center Marker, Aspect Marker, Check Filed, Underscan, Scan, Aspect, DSLR, Freeze, Peaking, False Color, Exposure, Histogram, Level Meter.

F1 user-definable function button

Default function:

Peaking

5. MENU OPERATION

When power on, press “MENU” on the device. The menu will display on the screen. Press “◀ / ▶” button to choose menu item. Then press “MENU” button to confirm.



Picture	Brightness	0~100	
	Contrast	0~100	
	Saturation	0~100	
	Tint	0~100	
	Sharpness	0~100	
	Color Temp	6500K, 7500K, 9300K, User (R.G. B)	
	Red Gain	0~255	Note: Available only under “User” mode to choose the color value you need.
	Green Gain	0~255	
	Blue Gain	0~255	
	Red Offset	0~511	
	Green Offset	0~511	
Blue Offset	0~511		

Brightness

Adjust the general brightness of the LCD. For example, if you are outside in bright conditions, increase the LCD brightness to make it easier to view.

Contrast

Increases or decreases the range between the bright and dark areas of the image. High contrast can reveal detail and depth in the image, and low contrast can make the image appear soft and flat.

Saturation

Increase or decreases the amount of color in the displayed image.

Sharpness

Increase or decrease the sharpness of the image. When the image sharpness is insufficient, increase the sharpness to make the image clearer.









Color Temp

Adjust the color temperature to make the image warmer (Yellow) or colder (Blue). Increase the value to make the image be warmer, decrease the value to make the image be colder. User can use this function to strengthen, weaken or balance the image color according requirements. The standard white light color temperature is 6500K.

Marker	Center Marker	ON, OFF
	Aspect Marker	OFF, 16:9, 1.85:1, 2.35:1, 4:3, 3:2
	Safety Marker	OFF, 95%, 93%, 90%, 88%, 85%, 80%
	Marker Color	Red, Green, Blue, White, Black
	Grid	OFF, ON
	Marker Mat	OFF, 1, 2, 3, 4, 5, 6, 7

	Thickness	2, 4, 6, 8
--	-----------	------------

MARKER

	Center Marker	Off
	Aspect Marker	Off
	Safety Marker	Off
	Marker Color	Off
	Grid	Off
	Marker Mat	Off
	Thickness	2
		

Center Marker

Select On, it will appear “+” marker on center of screen.

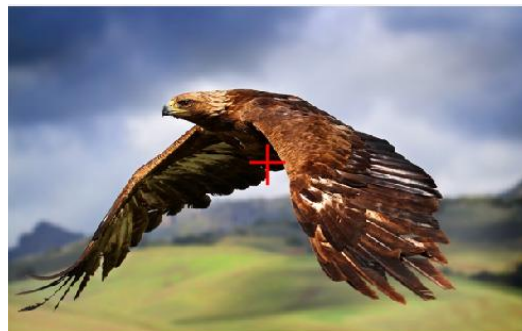

Aspect Marker

The Aspect Marker provides various aspect ratios, as the following:



Safety Marker

Draw dotted line Marker on screen in case of image. This monitor has OFF, 95%, 93%, 90%, 88%, 85%, 80% preset to choose.

Grid

The grid feature displays a “thirds” overlay with two vertical and horizontal lines placed in each third of the image. Select “ON” or “OFF” to view or hide the thirds

overlay.

Thirds are an extremely powerful tool to help compose the shots. For example, the human eye typically looks for action near the points where the lines intersect, so it's help to frame key points of interest in these zones.

Note: Grid function is unavailable while activate Marker Mat.

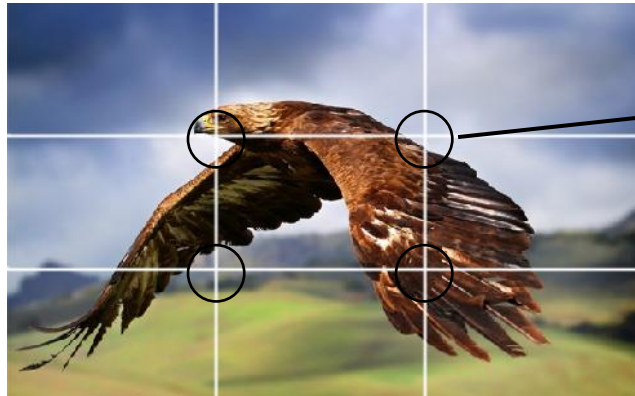







The points where the lines intersect.

Marker Color & Marker Mat & Thickness

The transparency of aspect mat can be adjusted from 0 to 7. Meanwhile, there are five alternative marker colors. The marker thickness can be set as 2,4,6. Users can choose abundant ratios or colors according to different background colors when shooting.



FUNCTION		
	Scan	Aspect
	Aspect	Full
	Underscan	On
	Check Field	Off
	Zoom	X2
	Freeze	Off
	DSLR	Off
		

Scan

Use this menu option to choose Scan mode. There are three modes preset:

- **Aspect:**

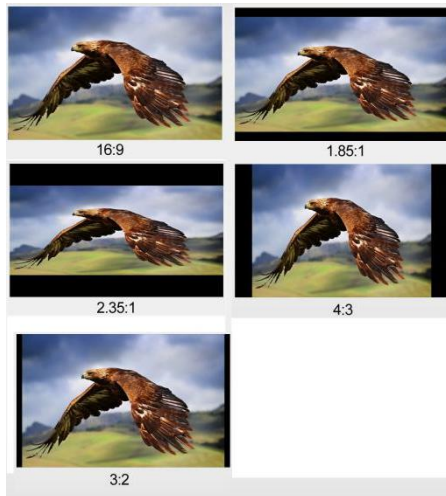

Select Aspect under Scan option, then use Aspect option to switch between several aspect ratio setting. Users can select related aspect ratio according to different signal input to meet the best viewing experience.

For example:

In 4:3 mode, images are scaled up or down to fill the maximum 4:3 portion of the screen.

In 16:9 mode, images are scaled to fill the entire screen.

- **Pixel to Pixel**

The pixel to pixel is a monitor set to 1:1 pixel mapping with native fixed pixels, which avoids loss of sharpness due to scaling artifacts and normally avoids incorrect aspect ratio due to stretching.

- **Zoom**

Function	Scan	Aspect, Pixel To Pixel, Zoom
	Aspect	16:9, 1.85:1, 2.35:1, 4:3, 3:2
	Underscan	OFF, ON
	Check Field	OFF, Mono, Red, Green, Blue
	Zoom	x1.5, x 2, x 3, x 4
	Freeze	OFF, ON
	DSLR	OFF, 5D2, 5D3

Can see the enlarged image by (x1.5, x 2, x 3, x 4) ratios. To select the “zoom” under Scan, choose the times under Zoom option which underneath the Check Field option.

Underscan

If the image shows size error, use this setting to zoom in/out pictures

automatically when receiving HDMI signals

Check Field

Use the check field modes for monitor calibration or to analyze individual color components of an image. In Mono chrome mode, all color is disabled and only a grayscale image is shown. In Blue, Green, and Red check field modes, only the selected color will be shown.

DSLR

Use the DSLR Preset option to reduce the visibility of on screen indicators shown with popular DSLR cameras. The available options are:

5D2, 5D3

Waveform	Peaking	OFF, ON
	Peaking Color	Red, Green, Blue, White, Black
	Peaking Level	0~100
	False Color	OFF, ON
	Exposure	OFF, ON
	Exposure Level	0~100
	Histogram	OFF, ON

WAVEFORM		
	Peaking	Off
	Peaking Color	Red
	Peaking Level	+50
	False Color	Off
	Exposure	Off
	Exposure Level	+85
	Histogram	Off
		

Peaking

The peaking is used to aid the camera operator in obtaining the sharpest possible picture. Select “On” to display colored outlines around sharp areas of the image.

Peaking Color

Use this setting to change the color of focus assist lines to Red, Green, Blue, White, Black. Changing the color of the lines can help make them easier to see against similar colors in displayed image.

Peaking lever

Use this setting to adjust the level of focus sensitivity. If there are plenty of details of image with high contrast, it will display lots of focus assist lines that may cause visual interference. So, decrease the value of peaking lever to reduce the focus lines to see clearly. Conversely, if the image has less details with low contrast, it should be increase the value of peaking lever to see the focus lines clearly.



False Color

This monitor has a false color filter to aid in the setting of camera exposure. As the camera Iris is adjusted, elements of the image will change color based on the luminance or brightness values. This enables proper exposure to be achieved without the use of costly, complicated external equipment.



Exposure & Exposure Lever

The exposure feature helps the user achieve optimum exposure by displaying

diagonal lines over areas of the image that exceed the setting exposure level.

The exposure lever can be set to 0~100.

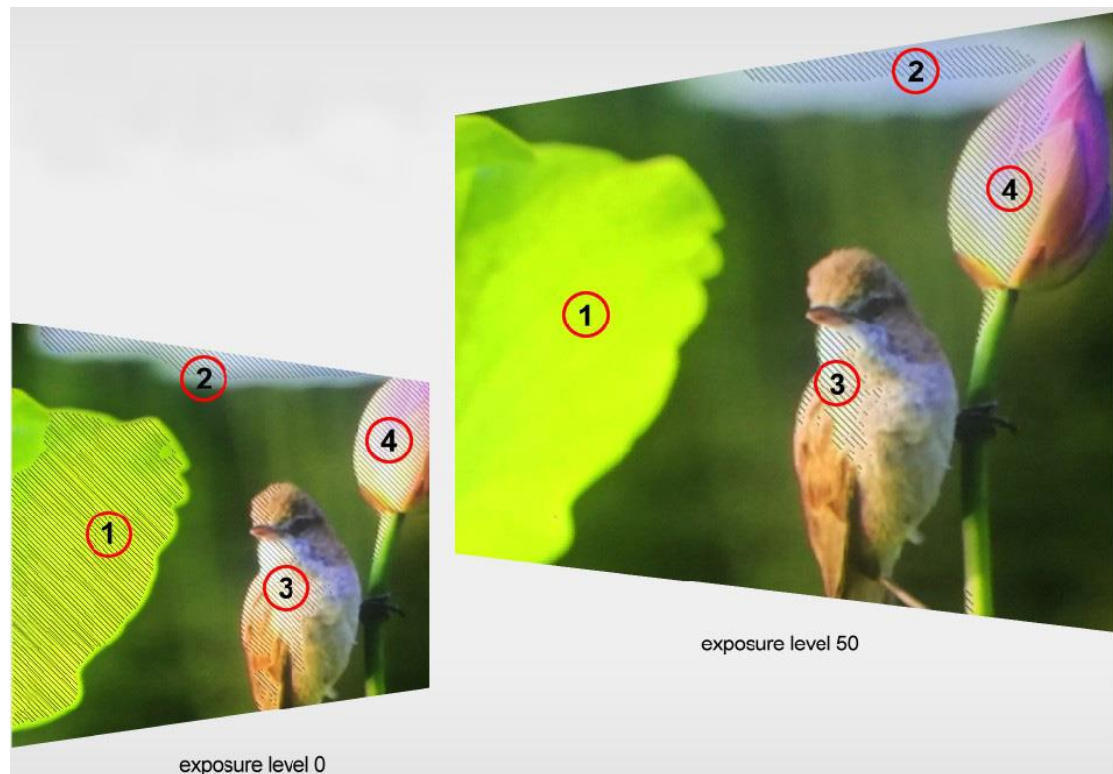

Histogram

The histogram shows the distribution of the luminance or the black to white information along a horizontal scale, and lets the user monitor how close the detail is to being clipped in the blacks or whites of the video. The histogram also lets you see the effects of gamma changes in the video.

The left edge of the histogram displays shadows, or blacks, and the far right displays highlights, or whites. If monitoring the image from a camera, when the user closes or opens the lens aperture, the information in the histogram moves to the left or right accordingly. The user can use this to check “clipping” in the image shadows and highlights, and also for a quick overview of the amount of detail visible in the tonal ranges. For example, a tall and broad range of information around the middle section of the histogram corresponds to good exposure for details in the midtones of your image.



Under exposure



Over exposure



Proper exposure

The video is likely being clipped if the information bunches to a hard edge at 0% or above 100% along the horizontal scale. Video clipping is undesirable when shooting, as detail in the blacks and whites must be preserved if the user subsequently want to perform color correction in a controlled environment. When shooting, try to maintain the exposure so information falls off gradually at the edges of the histogram with most forming around the middle. This will give the user more freedom later to adjust colors without whites and blacks

appearing flat and lacking in detail.

Audio	Volume	0~100
	Level Meter	OFF, ON

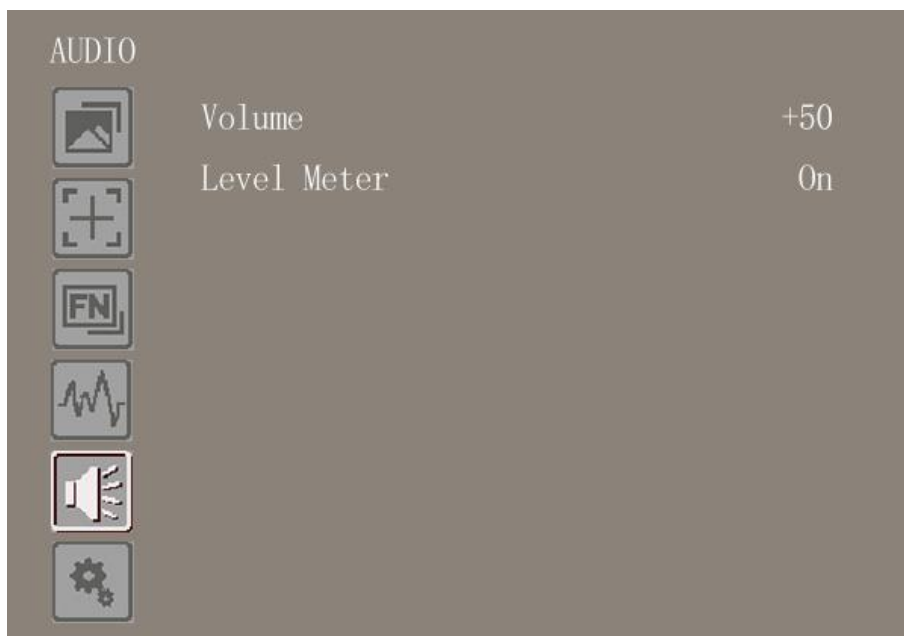

Volume

To adjust the volume for the built -in speaker and earphone jack audio signal.

Level Meter

The left side of the on screen meters displays level meters showing audio levels for channels 1 and 2 of the input source. It features peak hold indicators which stay visible for a short time so the user can clearly see the maximum levels reached.

To achieve optimum audio quality, ensure your audio levels do not reach 0. This is the maximum level, meaning that any audio that exceeds this level will be clipped, resulting in distortion. Ideally peak audio levels should fall in the upper end of the green zone. If the peaks enter into the yellow or red zones, the audio is in danger of clipping.



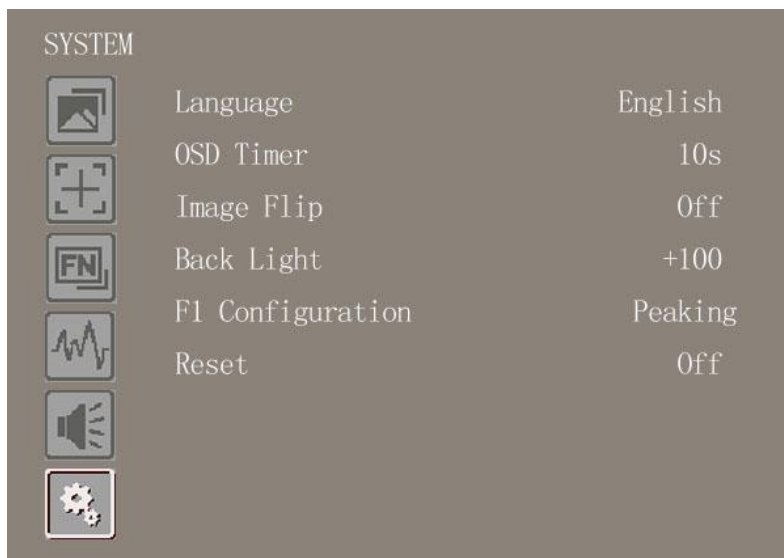

Language

Switch between English and Chinese.

OSD TIMER

Select the displaying time of the OSD. It has 10s,20s,30s preset to choose.

Image Flip

The image flip supports horizontal, Vertical and horizontal with vertical rotations, which provide multi viewing experience from different angles for users.

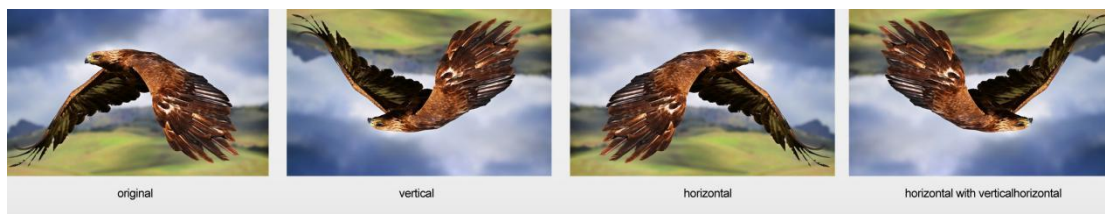

System	Language	English, Chinese
	OSD Timer	10s, 20s, 30s
	Image Flip	OFF, H, V, H/V
	Back Light	0~100
	F1 Configuration	Peaking (Default)
	Reset	Press to confirm after selected.

Back Light

Adjusts the back light strength of the panel. If the back light value is increased, the screen becomes brighter.

F1 Configuration

Select "F1 Configuration" for setting. Press "◀ / ▶" buttons to choose settings, then press the Menu button to confirm the selection. After set it, the user can press F1 to pop up the function directly on screen.

Reset

If there is any problem unknown, press to confirm after selected. The monitor will return to default set.

6. ACCESSORIES

Standard:



1. Folding sun shade cover

1 piece

2. HDMI A/C cable

1 piece

3. Hot shoe mount

1 piece

4. Manual

1 copy

7. PARAMETERS

8. TROUBLE SHOOTING

1. Only black-and-white display:

Check whether the color saturation is properly setup or not.

2. Power on but no pictures:

Check whether the cables of HDMI are correctly connected or not. Please use the standard battery.

3. Wrong or abnormal colors:

Check whether the cables are correctly and properly connected or not.

Broken or loose pins of the cables may cause a bad connection.

4. When on the picture shows size error:

Press “MENU → FUNCTION → Underscan” to zoom in/out pictures automatically when receiving HDMI signals

5. Other problems:

Please press dial button and choose “MENU→SYSTEM→ Reset →ON”

Panel	5" 8bit IPS
Physical Resolution	1920×1080 (441ppi)
Aspect Ratio	16:9
Brightness	400 cd/m ²
Contrast	1000: 1
Viewing Angle	170°/ 170°(H/V)
Input Voltage	DC 7-24V
Input Signal	HDMI
Output Signal	HDMI
Power Consumption	≤9W
Operating Temperature	-20□~50□
Storage Temperature	-30□~70□
Dimension (LWD)	129.6×80.1×23.6mm
Weight	118g

6. According to the ISP, the machine cannot function properly:

ISP for program upgrades, non-professionals do not use. Please reboot your device if press accidentally!

7. What's the external battery working time for monitor?

The monitor supports SONY F970 battery (working time is about 3.5hours or above) and Canon LP-E6 battery(working time is about 1.5hours or above), we kindly suggest using original battery of SONY and Canon brand. The working time is not guaranteed if using non original battery.

8. Is the USB interface supports power supply?

No. The USB interface is only for upgrading, not for power supply.

It may be caused a failure if supply power and out of warranty.

Note: Due to constant effort to improve products and product features, specifications may change without notice.